

INSTRUCTIONS

5519/266 pieces
Follow lines and dots for
proper assembly.

1

APPLY
STICKER



REMOVE
FROM
ACCESSORY
SPRUE

2 x 2 x 1/2
TOP
TO BOTTOM
HINGES

2 x 2 x 1/2
TOP
TO BOTTOM
HINGES

START
HERE

2

3

2 x 2 x 1/2
TOP TO TOP
HINGES

2 x 2 x 1/2
TOP
TO BOTTOM
HINGE

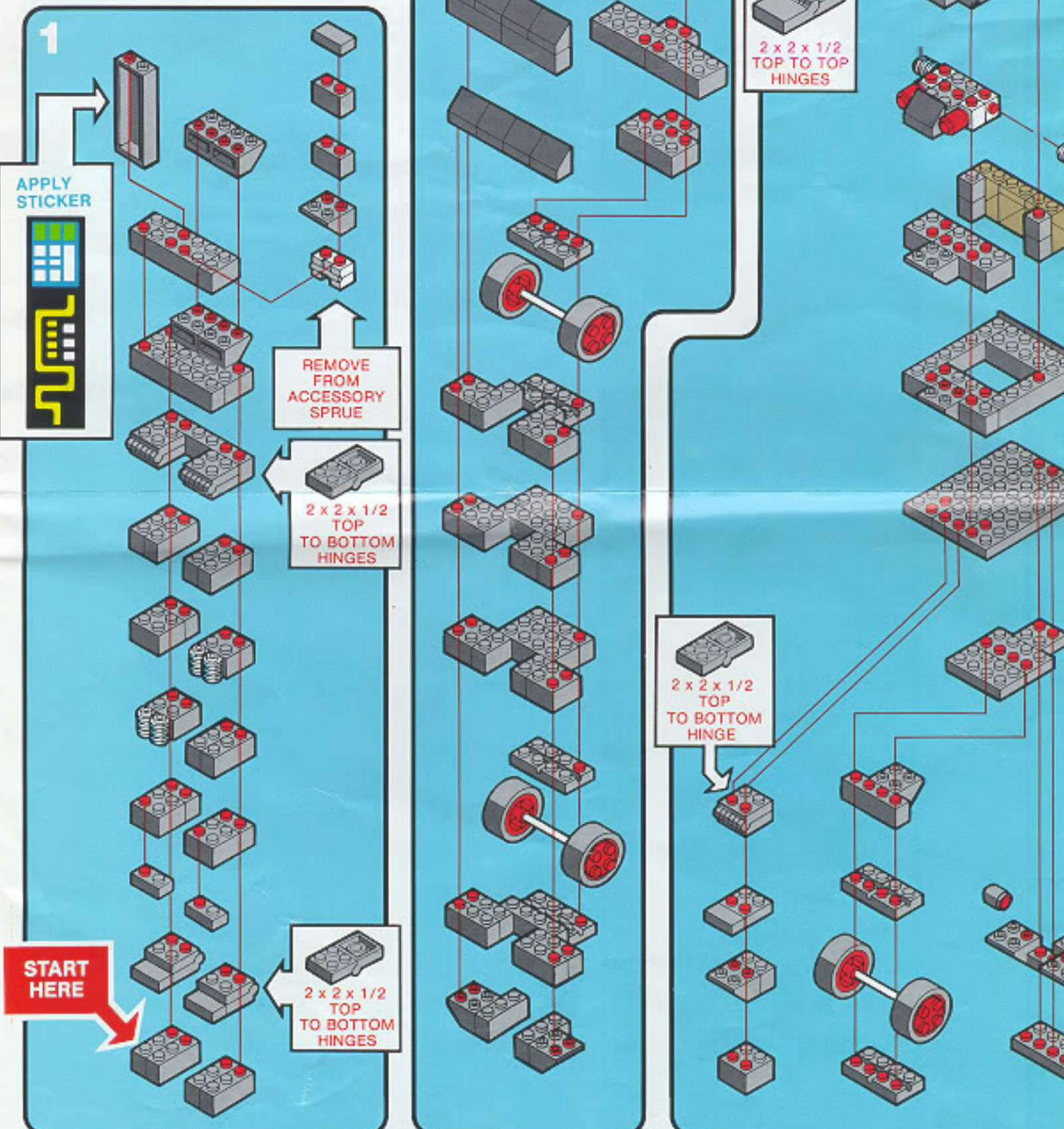

4

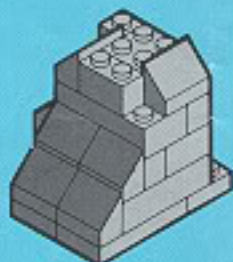
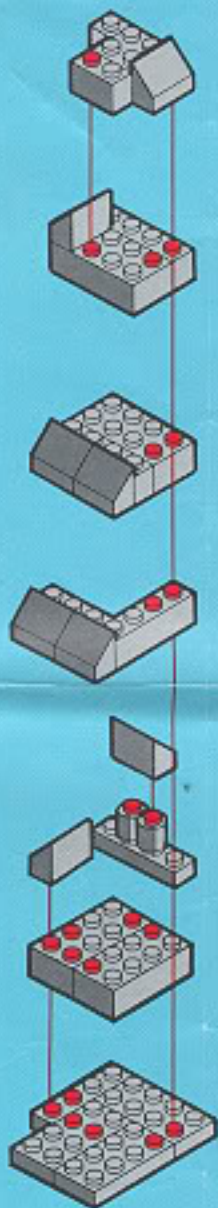

ASSEMBLED VIEW

5

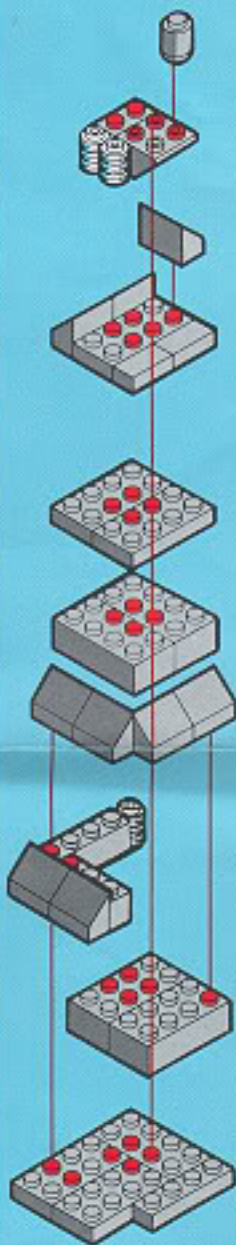

ASSEMBLED VIEW

6

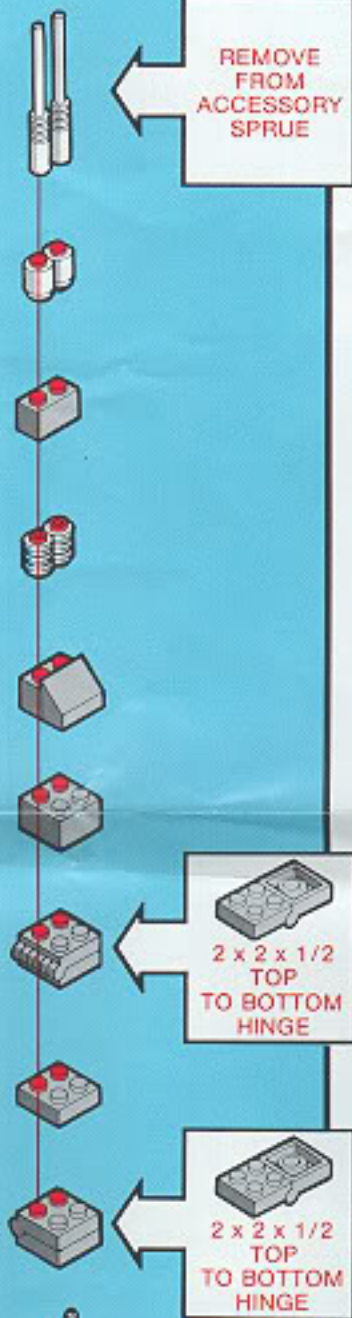

REMOVE FROM ACCESSORY SPRUE

2 x 2 x 1/2 TOP TO BOTTOM HINGE

2 x 2 x 1/2 TOP TO BOTTOM HINGE

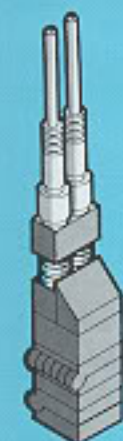

ASSEMBLED VIEW

7

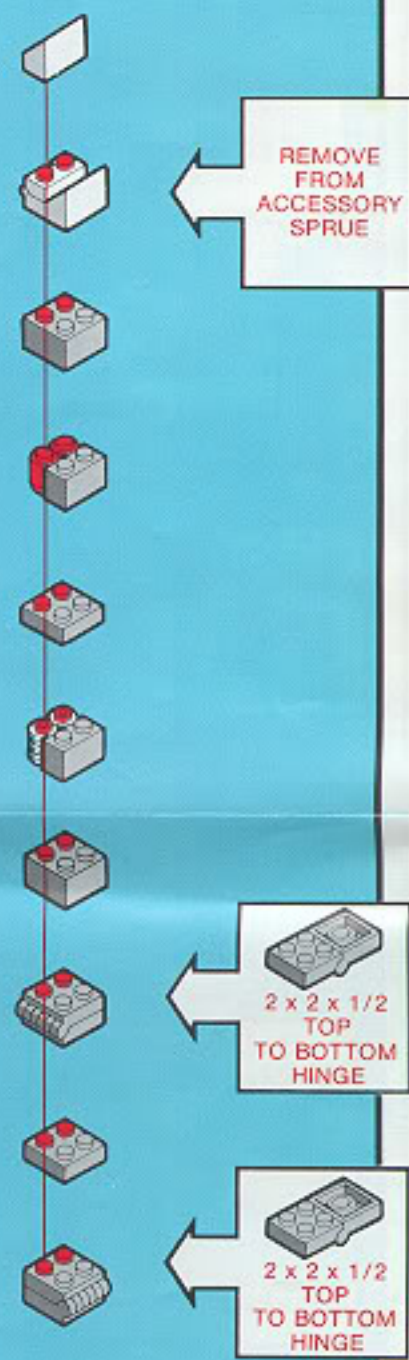

REMOVE FROM ACCESSORY SPRUE

2 x 2 x 1/2 TOP TO BOTTOM HINGE

2 x 2 x 1/2 TOP TO BOTTOM HINGE

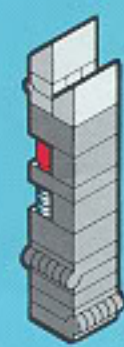

ASSEMBLED VIEW

FINAL ASSEMBLY

8

ASSEMBLY FROM STEP 6

ASSEMBLY FROM STEP 7

ASSEMBLY FROM STEP 2

ASSEMBLY FROM STEP 1

ASSEMBLY FROM STEP 4

ASSEMBLY FROM STEP 5

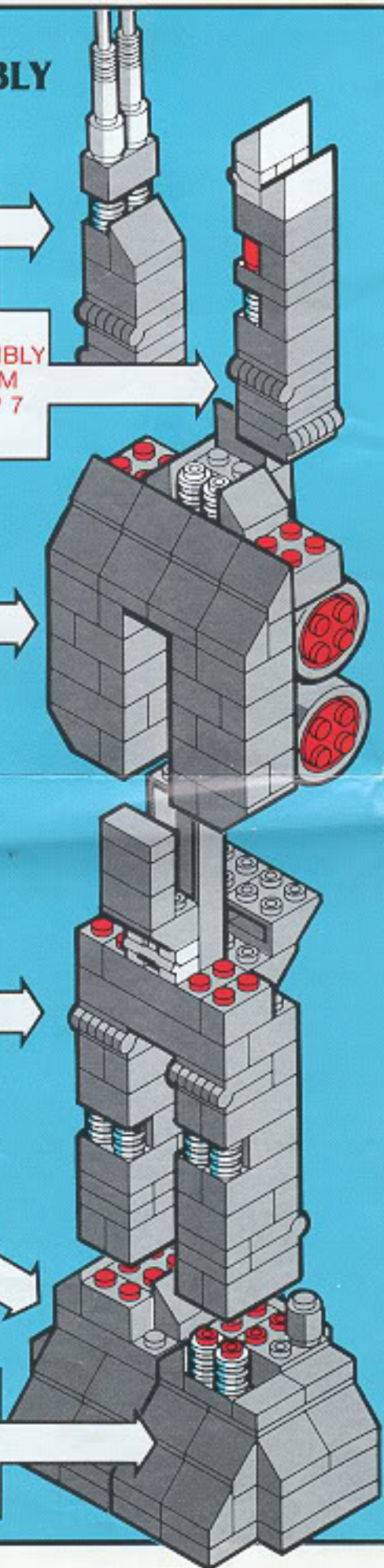

9

ASSEMBLY FROM STEP 3

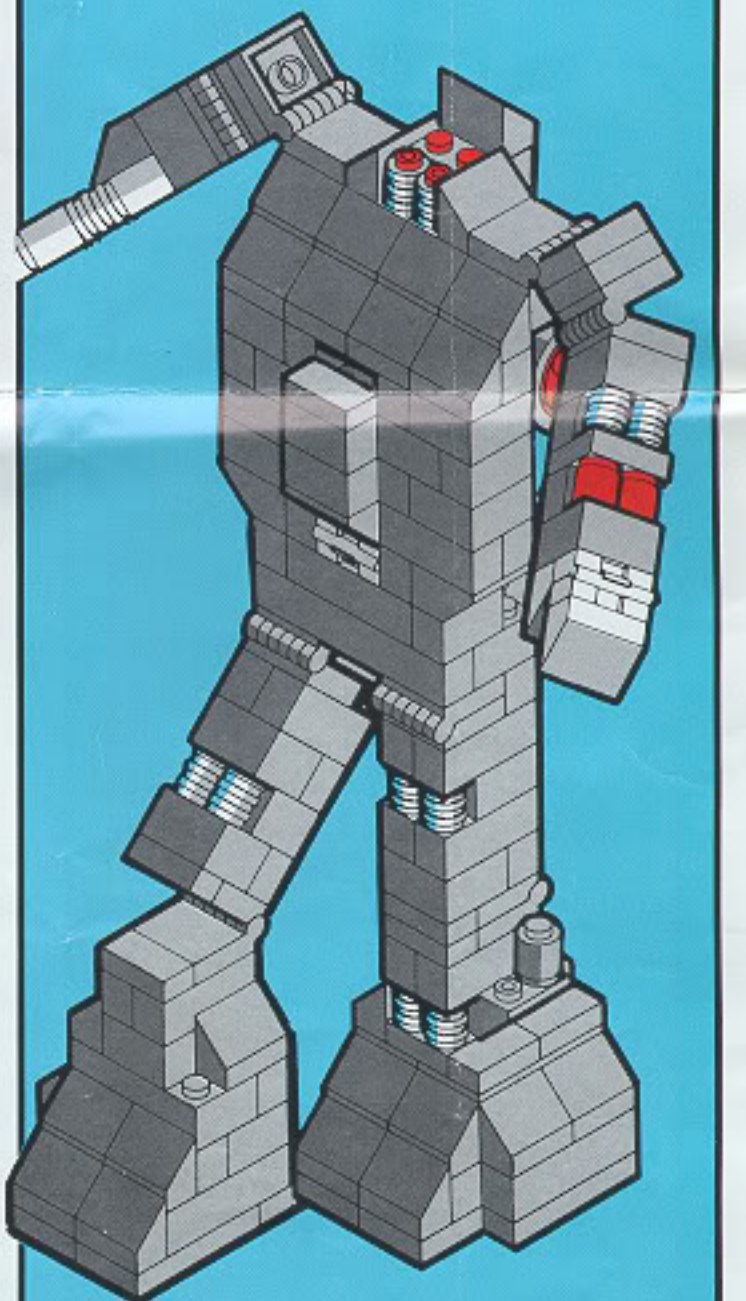



Before transforming your RoboBloxx apply stickers to strengthen weak connections. Refer to the photos on this page and the package for placement of stickers.

